

6-Channel LED Driver with I²C™ Interface

Description

The W-5626 is a high efficiency 1x/1.5x fractional charge pump with programmable dimming current in six LED channels. To ensure uniform brightness in LCD backlight applications, each LED channel delivers an accurate regulated current.

Low noise and input ripple is achieved by operating at a constant switching frequency of 1 MHz which allows the use of small external ceramic capacitors. The 1x/1.5x fractional charge pump supports a wide range of input voltages from 3 V to 5.5 V with efficiency up to 91%, and is ideal for Li-Ion battery powered devices.

The LED channels are configured into three independent pairs, each containing 2 matched channels. Each pair can be separately programmed from zero to 32 mA, in 0.5 mA resolution steps, using the I²C serial interface. Any individual channel can be disabled while others remain active. When the enable input (EN) is low, the device is in shutdown mode drawing zero current.

The device is available in a 16-pad TQFN package with a max height of 0.8 mm.

Features

- Drives 6 LED Channels
- Independent Current on 3 Pairs of LEDs
- I²C Serial Interface Programming
- Adjustable Current to 32 mA in 0.5 mA Step
- Power Efficiency up to 91%
- Fractional Pump 1x/1.5x
- Low Noise Input Ripple
- Fixed High Frequency Operation 1 MHz
- “Zero” Current Shutdown Mode
- Soft Start and Current Limiting
- Short Circuit Protection
- Thermal Shutdown Protection
- These Devices are Pb-Free, Halogen Free/BFR Free and are RoHS Compliant

Applications

- RGB LEDs
- LCD and Keypad Backlighting
- Cellular Phones, PDAs
- Digital Cameras



TQFN-16

PIN CONNECTIONS

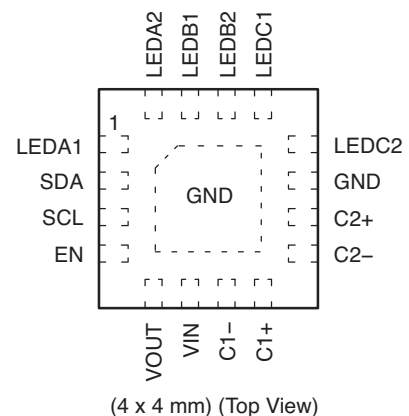

MARKING DIAGRAMS



CDAJ = W-5626HV4-GT2
 A = Assembly Location
 XXX = Last Three Digits of Assembly Lot Number
 Y = Production Year (Last Digit)
 M = Production Month (1-9, A, B, C or O, N, D)
 CC = Country of Origin (Two Digit)

ORDERING INFORMATION

Device	Package	Shipping
W-5626HV4-GT2 (Note 1)	TQFN-16 (Pb-Free)	2,000/ Tape & Reel

1. NiPdAu Plated Finish (RoHS-compliant).

W-5626

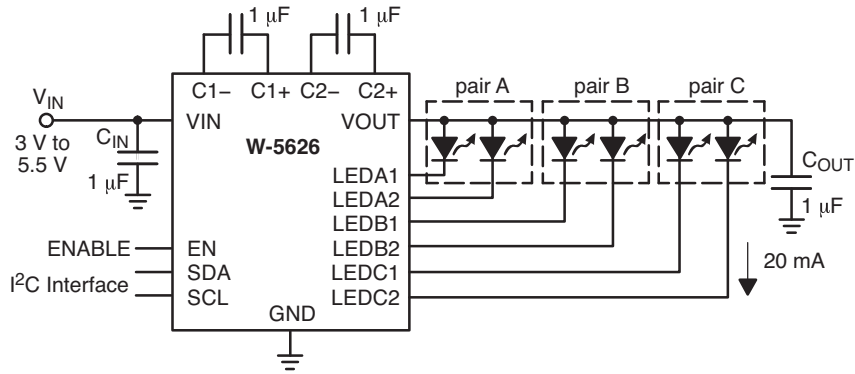

Figure 1. Typical Application Circuit

Table 1. ABSOLUTE MAXIMUM RATINGS

Parameters	Ratings	Units
VIN, LEDxx voltage	6	V
VOUT, C1±, C2± voltage	7	V
EN, SDA, SCL voltage	VIN + 0.7 V	V
Storage Temperature Range	-65 to +160	°C
Junction Temperature Range	-40 to +150	°C
Lead Temperature	300	°C

Stresses exceeding Maximum Ratings may damage the device. Maximum Ratings are stress ratings only. Functional operation above the Recommended Operating Conditions is not implied. Extended exposure to stresses above the Recommended Operating Conditions may affect device reliability.

Table 2. RECOMMENDED OPERATING CONDITIONS

Parameter	Range	Units
VIN	3 to 5.5	V
Ambient Temperature Range	-40 to +85	°C
LED forward voltage	Up to 4.2	V
I _{LED} per LED pin	0 to 32	mA

NOTE: Typical application circuit with external components is shown above.

W-5626

Table 3. ELECTRICAL OPERATING CHARACTERISTICS

$V_{IN} = 3.6\text{ V}$, EN = High, ambient temperature of 25°C (over recommended operating conditions unless specified otherwise)

Symbol	Parameter	Test Conditions	Min	Typ	Max	Units
I_Q	Quiescent Current	1x mode, all LEDs Off 1x mode, all LEDs On 1.5x mode, all LEDs Off		0.5 2.2 3.5		mA
I_{QSHDN}	Shutdown Current	$V_{EN} = 0\text{ V}$		0	1	μA
I_{LED}	LED Current Range with 6 LEDs		0		32	mA
$I_{LED-ACC}$	LED Current Accuracy	$1\text{ mA} \leq I_{LED} \leq 31\text{ mA}$		± 3		%
$I_{LED-DEV}$	LED Channel Matching	$(I_{LED} - I_{LEDAVG}) / I_{LEDAVG}$		± 3		%
R_{OUT}	Output Resistance (open loop)	1x mode, $I_{OUT} = 120\text{ mA}$ 1.5x mode, $I_{OUT} = 120\text{ mA}$		0.5 2.8		Ω
F_{OSC}	Charge Pump Frequency		0.8	1	1.3	MHz
I_{SC_MAX}	Output short circuit Current Limit	$V_{OUT} < 0.5\text{ V}$		60		mA
I_{IN_MAX}	Input Current Limit	1x mode, $V_{OUT} > 1\text{ V}$		300		mA
I_{EN} V_{HI-EN} V_{LO-EN}	EN Pin – Input Leakage – Logic High Level – Logic Low Level		-1 1.3		1 0.4	μA V V
V_{HI} V_{LO}	I ² C SDA, SCL – High Level Input Voltage – Low Level Input Voltage		$0.7 \times V_{IN}$		$0.3 \times V_{IN}$	V V
T_{SD}	Thermal Shutdown			165		°C
T_{HYS}	Thermal Hysteresis			20		°C
V_{UVLO}	Under-voltage lock out (UVLO) threshold			2		V

W-5626

Table 4. A.C. CHARACTERISTICS For $3\text{ V} \leq V_{\text{IN}} \leq 5.5\text{ V}$, over full ambient temperature range -40°C to $+125^{\circ}\text{C}$ (over recommended operating conditions unless specified otherwise).

Symbol	Parameter	Min	Typ	Max	Unit
f_{SCL}	Clock Frequency			400	kHz
t_{AA}	SCL Low to SDA Data Out and ACK Out			0.9	μs
t_{BUF}	Bus Free Time Before a New Transmission Can Start	1.2			μs
$t_{\text{HD:STA}}$	Start Condition Hold Time	0.6			μs
t_{LOW}	Clock Low Period	1.2			μs
t_{HIGH}	Clock High Period	0.6			μs
$t_{\text{SU:STA}}$	Start Condition Setup Time (For a Repeated Condition)	0.6			μs
$t_{\text{HD:DAT}}$	Data In Hold Time	0			ns
$t_{\text{SU:DAT}}$	Data In Setup Time	100			ns
t_{R}	SDA and SCL Rise Time			0.3	μs
t_{F}	SDA and SCL Fall Time			300	ns
$t_{\text{SU:STO}}$	Stop Condition Setup Time	0.6			μs
t_{DH}	Data Out Hold Time	50			ns

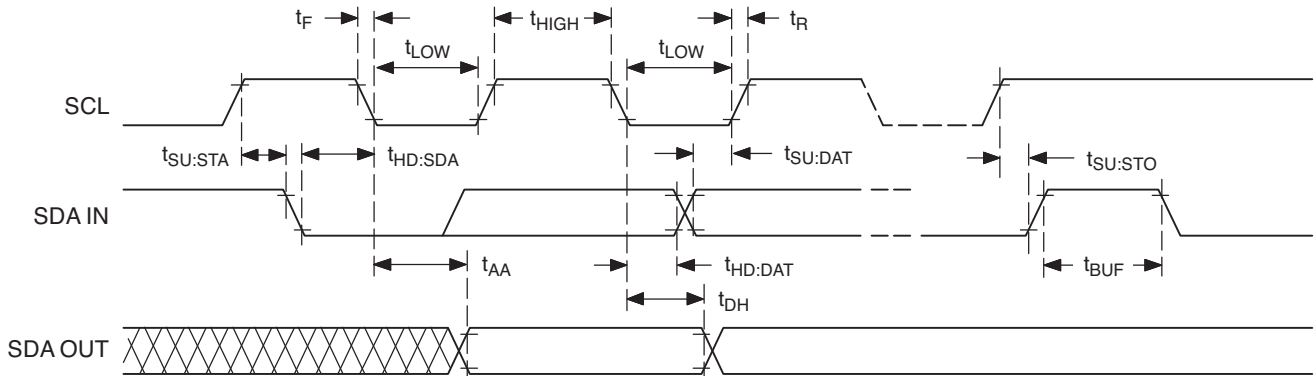

Figure 2. I²C Bus Timing Characteristics

W-5626

TYPICAL CHARACTERISTICS

($V_{IN} = 3.6\text{ V}$, $I_{OUT} = 90\text{ mA}$ (6 LEDs at 15 mA), $EN = V_{IN}$, $C_{IN} = C_1 = C_2 = C_{OUT} = 1\ \mu\text{F}$, $T_{AMB} = 25^\circ\text{C}$, unless otherwise specified.)

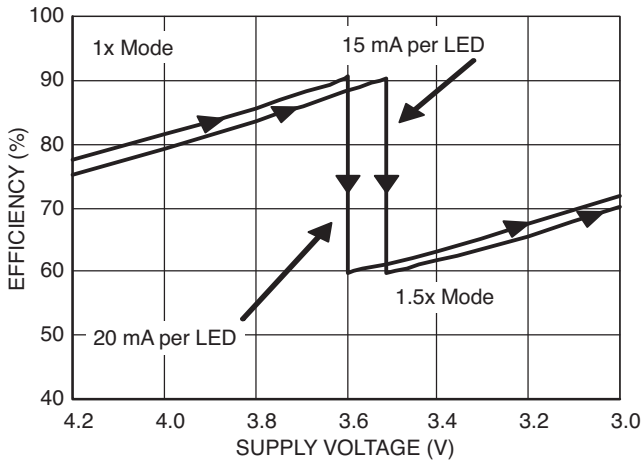

Figure 3. Efficiency vs. Supply Voltage (6 LEDs)

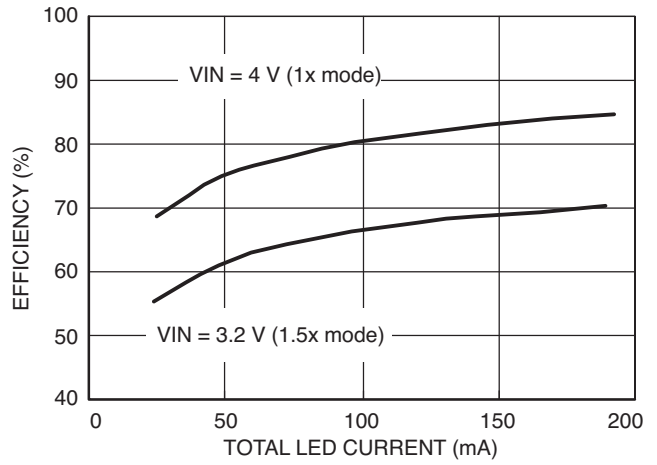

Figure 4. Efficiency vs. Total LED Current (6 LEDs)

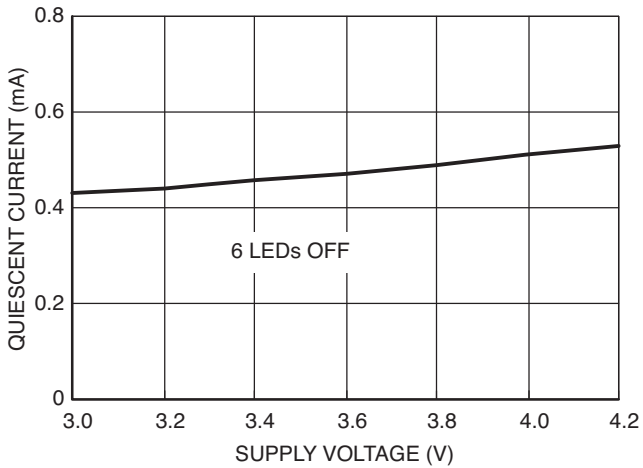

Figure 5. Quiescent Current vs. Supply Voltage (1x Mode)

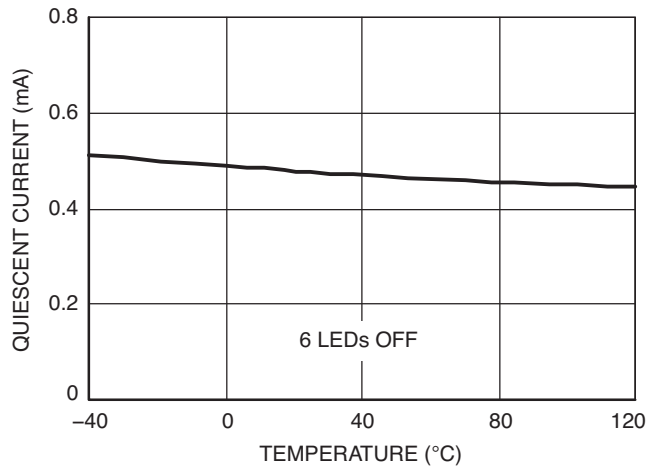

Figure 6. Quiescent Current vs. Temperature (1x Mode)

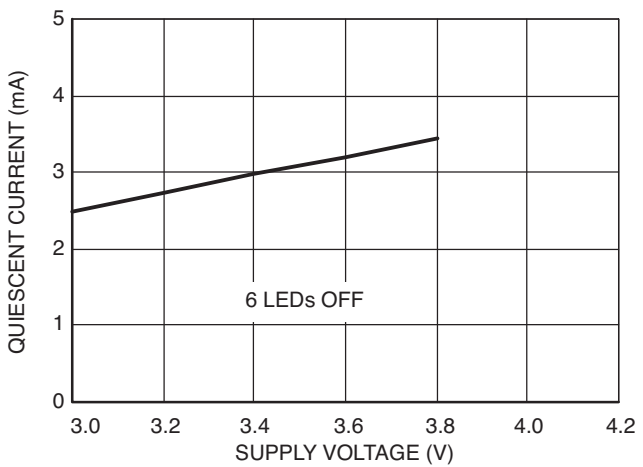

Figure 7. Quiescent Current vs. Supply Voltage (1.5x Mode)

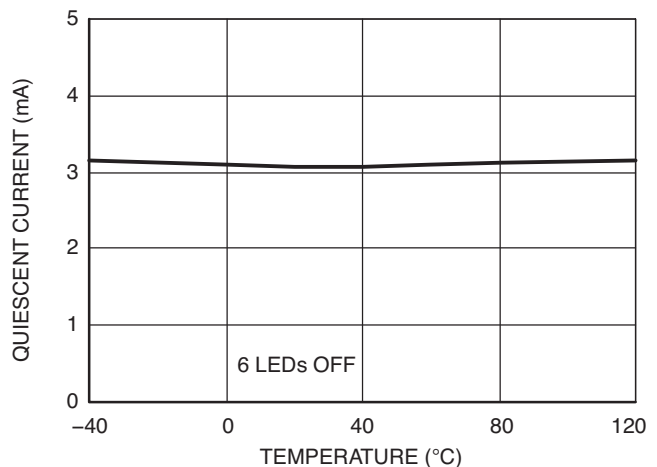

Figure 8. Quiescent Current vs. Temperature (1.5x Mode)

W-5626

TYPICAL CHARACTERISTICS

($V_{IN} = 3.6\text{ V}$, $I_{OUT} = 90\text{ mA}$ (6 LEDs at 15 mA), $EN = V_{IN}$, $C_{IN} = C_1 = C_2 = C_{OUT} = 1\ \mu\text{F}$, $T_{AMB} = 25^\circ\text{C}$, unless otherwise specified.)

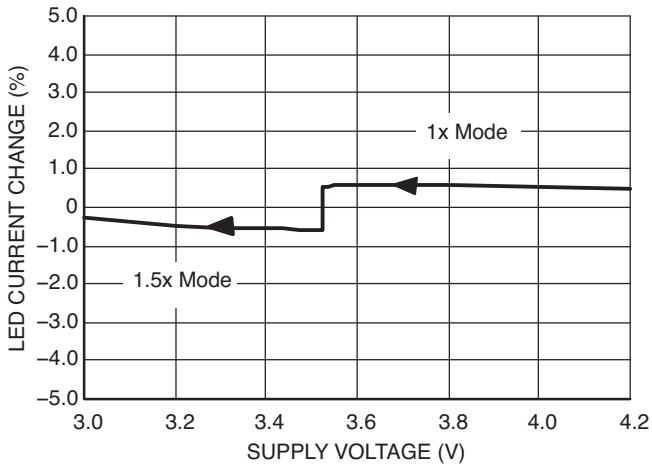

Figure 9. LED Current Change vs. Supply Voltage

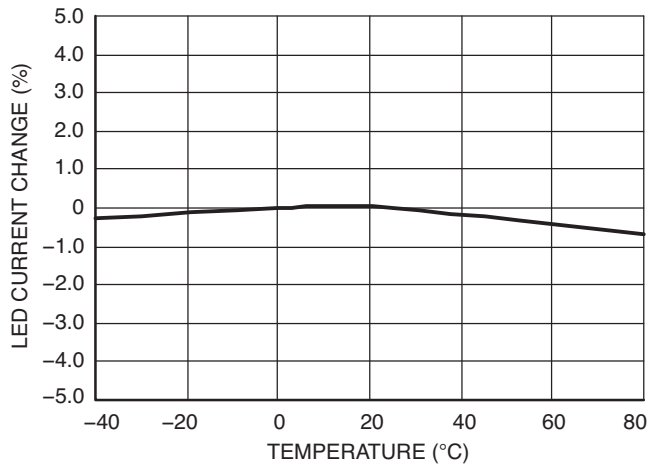

Figure 10. LED Current Change vs. Temperature

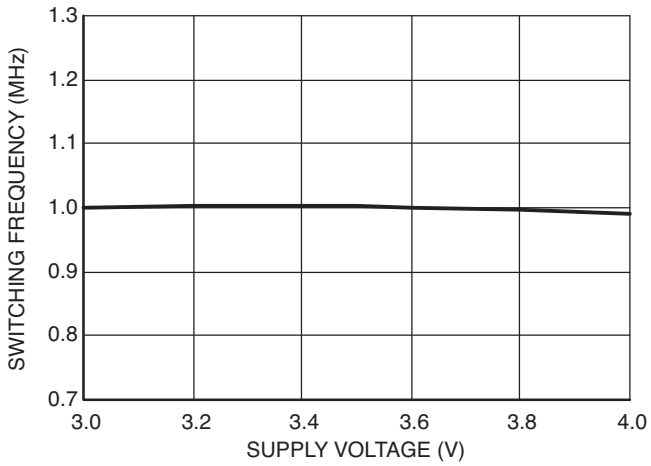

Figure 11. Switching Frequency vs. Supply Voltage

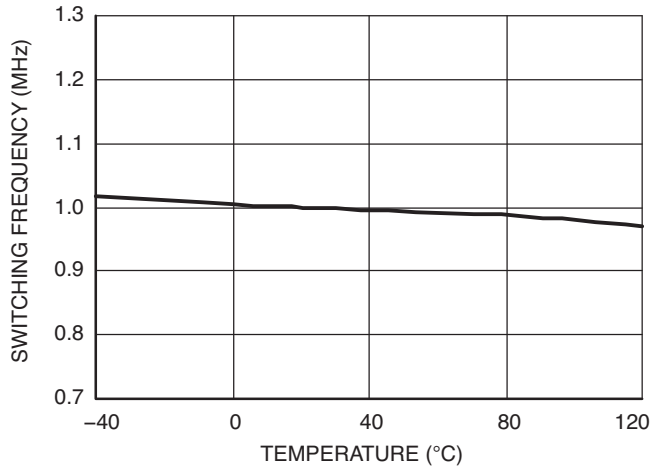

Figure 12. Switching Frequency vs. Temperature

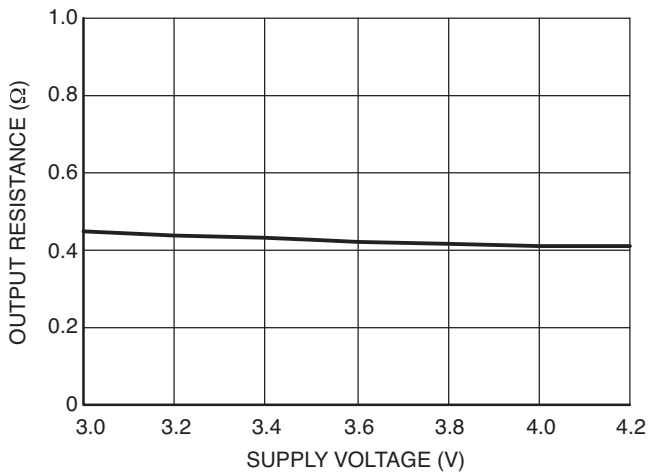

Figure 13. Output Resistance vs. Supply Voltage (1x Mode)

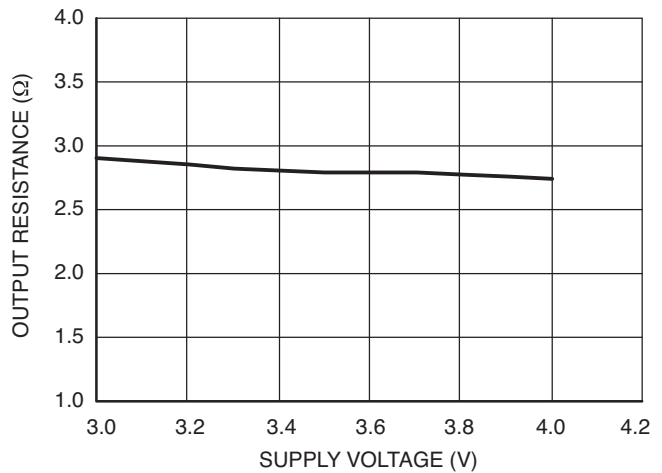

Figure 14. Output Resistance vs. Supply Voltage (1.5x Mode)

W-5626

TYPICAL CHARACTERISTICS

($V_{IN} = 3.6\text{ V}$, $I_{OUT} = 90\text{ mA}$ (6 LEDs at 15 mA), $EN = V_{IN}$, $C_{IN} = C_1 = C_2 = C_{OUT} = 1\ \mu\text{F}$, $T_{AMB} = 25^\circ\text{C}$, unless otherwise specified.)

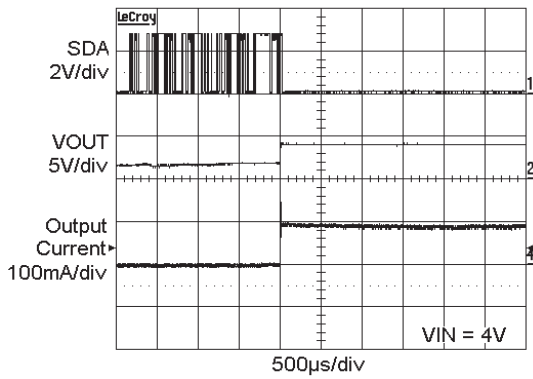

Figure 15. Power Up with 6 LEDs at 15 mA (1x Mode)

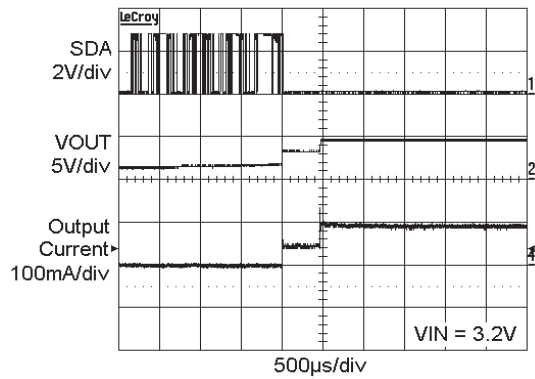

Figure 16. Power Up with 6 LEDs at 15 mA (1.5x Mode)

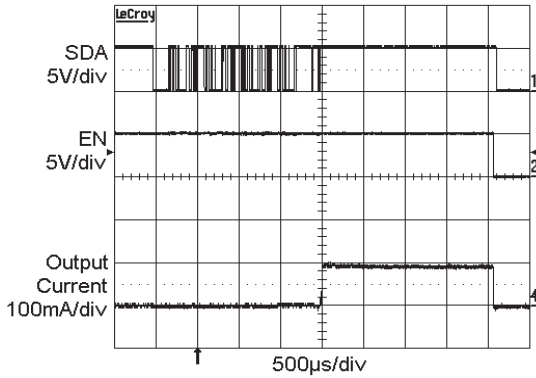

Figure 17. Enable Power Down (1x Mode)

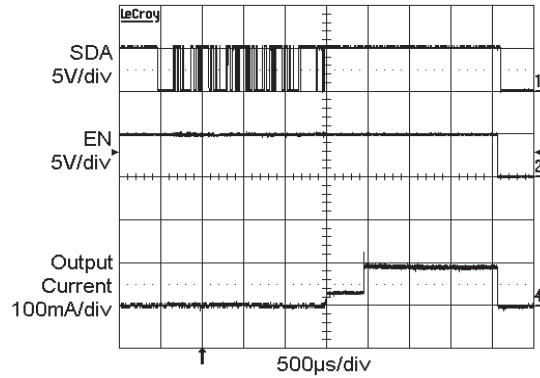

Figure 18. Enable Power Down (1.5x Mode)

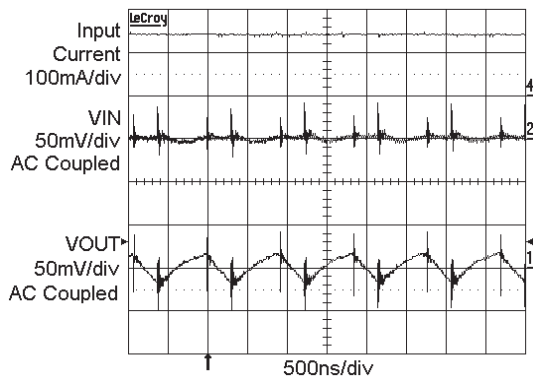

Figure 19. Switching Waveforms in 1.5x Mode

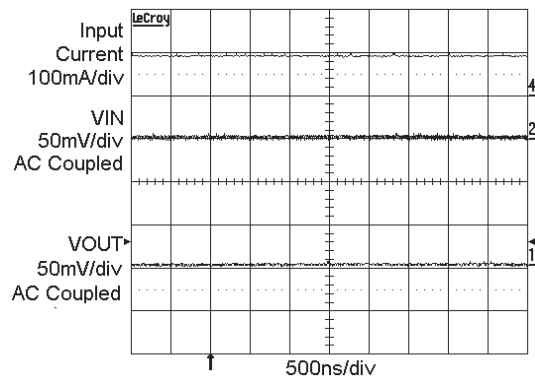

Figure 20. Operating Waveforms in 1x Mode

W-5626

TYPICAL CHARACTERISTICS

($V_{IN} = 3.6\text{ V}$, $I_{OUT} = 90\text{ mA}$ (6 LEDs at 15 mA), $EN = V_{IN}$, $C_{IN} = C_1 = C_2 = C_{OUT} = 1\ \mu\text{F}$, $T_{AMB} = 25^\circ\text{C}$, unless otherwise specified.)

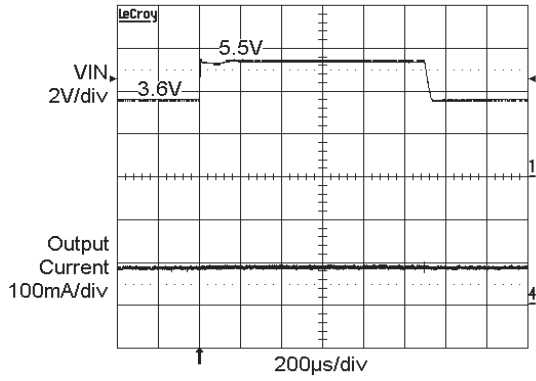

Figure 21. Line Transient Response in 1x Mode

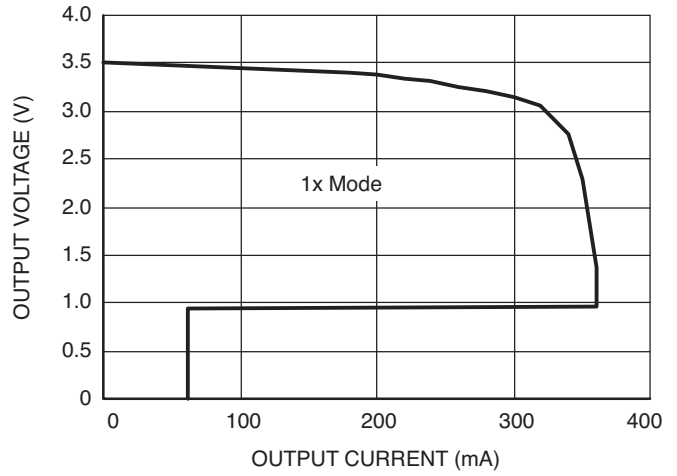

Figure 22. Foldback Current Limit

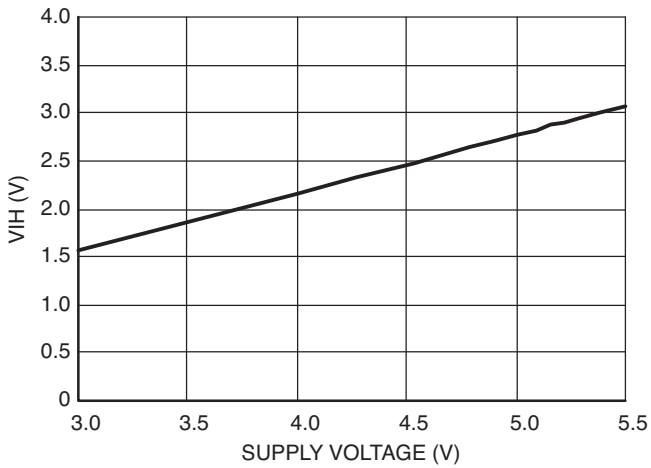

Figure 23. SDA, SCL V_{IH} vs. Supply Voltage

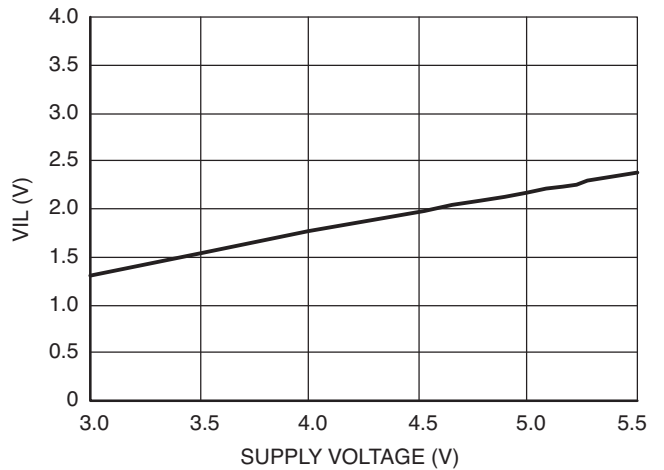

Figure 24. SDA, SCL V_{IL} vs. Supply Voltage

Table 5. PIN DESCRIPTIONS

Pin #	Name	Function
1	LEDA1	Cathode terminal of LED A1
2	SDA	I ² C Serial data input/output
3	SCL	I ² C Serial clock input
4	EN	Enable input
5	VOUT	Charge pump output connected to the LED anodes
6	VIN	Supply voltage
7	C1-	Bucket capacitor 1 terminal
8	C1+	Bucket capacitor 1 terminal
9	C2-	Bucket capacitor 2 terminal
10	C2+	Bucket capacitor 2 terminal
11	GND	Ground reference
12	LEDC2	Cathode terminal of LED C2
13	LEDC1	Cathode terminal of LED C1
14	LEDB2	Cathode terminal of LED B2
15	LEDB1	Cathode terminal of LED B1
16	LEDA2	Cathode terminal of LED A2
	TAB	Connect to Ground on PCB

Pin Function

VIN is the supply pin for the charge pump. A small 1 μ F ceramic bypass capacitor is required between the VIN pin and ground near the device. The operating input voltage range is from 2.2 V to 5.5 V. Whenever the input supply falls below the undervoltage threshold (2 V), all LEDs channels will be automatically disabled.

EN is the enable logic input for the driver. Guaranteed levels of logic high and logic low are set at 1.3 V and 0.4 V respectively. When EN is initially taken high, the device becomes enabled and all LED currents remain at 0 mA. To place the device into zero current shutdown mode, the EN pin must be held low.

SDA is the I²C serial data line. This is a bidirectional line allowing data to be written into and read from the four registers in the driver. Registers RegA/B/C set the LED current in each pair of channels, while RegEn sets the On/Off state independently of each channel.

SCL is the I²C serial clock input.

VOUT is the charge pump output that is connected to the LED anodes. A small 1 μ F ceramic bypass capacitor is required between the VOUT pin and ground near the device.

GND is the ground reference for the charge pump. The pin must be connected to the ground plane on the PCB.

C1+, **C1-** are connected to each side of the 1 μ F ceramic bucket capacitor C1.

C2+, **C2-** are connected to each side of the 1 μ F ceramic bucket capacitor C2.

LEDxx provide the internally regulated current to the six LED cathodes. These pins enter a high-impedance zero-current state whenever the device is placed in shutdown mode. In applications using less than six LEDs, the unused channels should be disabled through the RegEn register.

TAB is the exposed pad underneath the package. For best thermal performance, the tab should be soldered to the PCB and connected to the ground plane.

Block Diagram

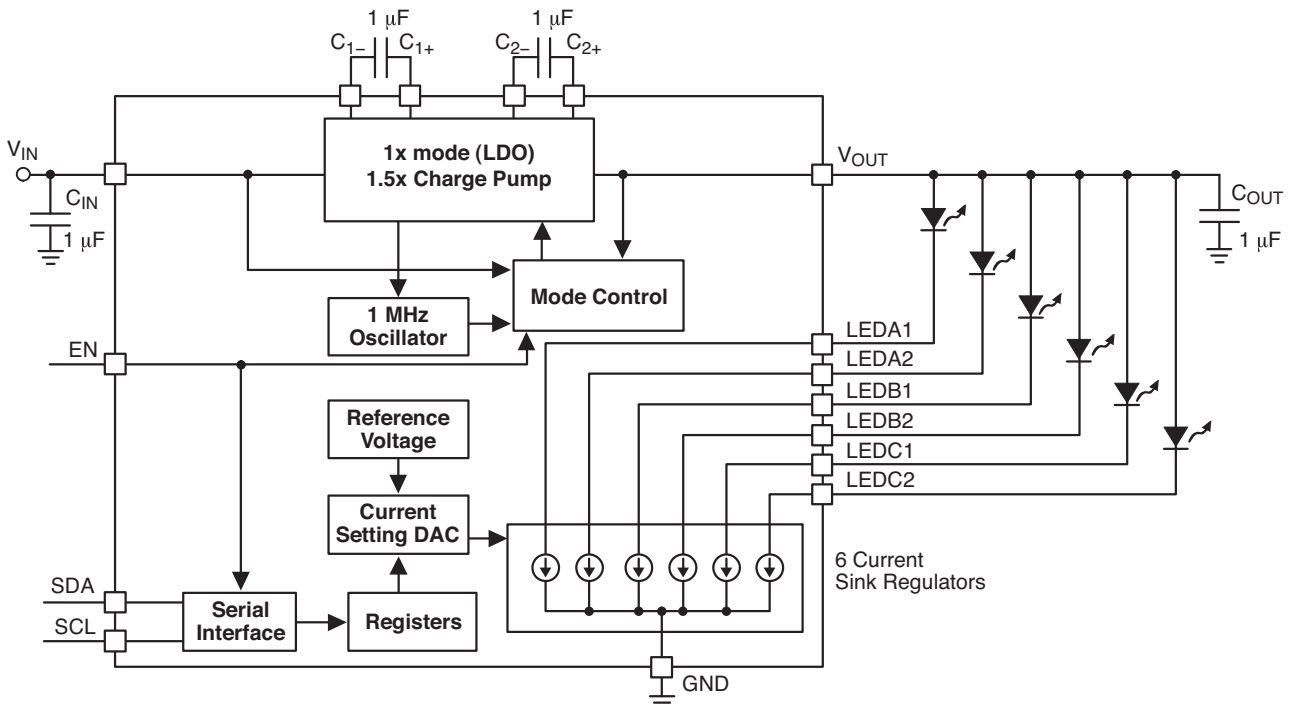

Figure 25. W-5626 Functional Block Diagram

Basic Operation

At power-up, the W-5626 starts operating in 1x mode where the output will be approximately equal to the input supply voltage (less any internal voltage losses). If the output voltage is sufficient to regulate all LEDs currents the device remains in 1x operating mode.

If the input voltage is insufficient or falls to a level where the regulated currents cannot be maintained, the device automatically switches (after a fixed time of 400 μs) into 1.5x mode.

In 1.5x mode, the output is approximately equal to 1.5 times the input supply voltage (less any internal voltage losses).

The above sequence is repeated each and every time the chip is either powered-up or taken out of shutdown (via EN pin), or the RegEn register is accessed by write cycle.

LED Current Setting

The LED current setting is programmed via the I²C serial interface and is stored in four 8-bit registers RegA, RegB, RegC and RegEn as follows:

- RegA stores the LED current for group A (LEDA1 and LEDA2 channels),
- RegB stores the LED current for group B (LEDB1 and LEDB2 channels),
- RegC stores the LED current for group C (LEDC1 and LEDC2 channels),
- RegEn selects the on/off state of each of the 6 LED channels.

At each write access to RegEn, the driver automatically reconfigures to the mode (1x or 1.5x) that provides the highest efficiency.

Table 6. REGISTER ADDRESS AND DATA CONFIGURATION (Note 3)

Register Name	Register Address	Bit Pattern							
		Bit 7	Bit 6	Bit 5	Bit 4	Bit 3	Bit 2	Bit 1	Bit 0
RegA	0	X	X	See Table 7 for values					
RegB	1	X	X						
RegC	2	X	X						
RegEn	3	X	X	LEDC2 On = 1 Off = 0	LEDC1 On = 1 Off = 0	LEDB2 On = 1 Off = 0	LEDB1 On = 1 Off = 0	LEDA2 On = 1 Off = 0	LEDA1 On = 1 Off = 0

3. X = not used, 1 = logic high, 0 = logic low

W-5626

The Table 7 lists the various LED currents with the associated RegA, RegB, and RegC register values.

Table 7. LED CURRENT SELECTION AND REGISTER VALUE (Note 4)

LED Current (mA)	D7	D6	D5	D4	D3	D2	D1	D0	Dec
0.5	X	X	0	0	0	0	0	0	0
1.0	X	X	0	0	0	0	0	1	1
1.5	X	X	0	0	0	0	1	0	2
2.0	X	X	0	0	0	0	1	1	3
2.5	X	X	0	0	0	1	0	0	4
3.0	X	X	0	0	0	1	0	1	5
3.5	X	X	0	0	0	1	1	0	6
4.0	X	X	0	0	0	1	1	1	7
4.5	X	X	0	0	1	0	0	0	8
5.0	X	X	0	0	1	0	0	1	9
5.5	X	X	0	0	1	0	1	0	10
6.0	X	X	0	0	1	0	1	1	11
6.5	X	X	0	0	1	1	0	0	12
7.0	X	X	0	0	1	1	0	1	13
7.5	X	X	0	0	1	1	1	0	14
8.0	X	X	0	0	1	1	1	1	15
8.5	X	X	0	1	0	0	0	0	16
9.0	X	X	0	1	0	0	0	1	17
9.5	X	X	0	1	0	0	1	0	18
10.0	X	X	0	1	0	0	1	1	19
10.5	X	X	0	1	0	1	0	0	20
11.0	X	X	0	1	0	1	0	1	21
11.5	X	X	0	1	0	1	1	0	22
12.0	X	X	0	1	0	1	1	1	23
12.5	X	X	0	1	1	0	0	0	24
13.0	X	X	0	1	1	0	0	1	25
13.5	X	X	0	1	1	0	1	0	26
14.0	X	X	0	1	1	0	1	1	27
14.5	X	X	0	1	1	1	0	0	28
15.0	X	X	0	1	1	1	0	1	29
15.5	X	X	0	1	1	1	1	0	30
16.0	X	X	0	1	1	1	1	1	31

LED Current (mA)	D7	D6	D5	D4	D3	D2	D1	D0	Dec
16.5	X	X	1	0	0	0	0	0	32
17.0	X	X	1	0	0	0	0	1	33
17.5	X	X	1	0	0	0	1	0	34
18.0	X	X	1	0	0	0	1	1	35
18.5	X	X	1	0	0	1	0	0	36
19.0	X	X	1	0	0	1	0	1	37
19.5	X	X	1	0	0	1	1	0	38
20.0	X	X	1	0	0	1	1	1	39
20.5	X	X	1	0	1	0	0	0	40
21.0	X	X	1	0	1	0	0	1	41
21.5	X	X	1	0	1	0	1	0	42
22.0	X	X	1	0	1	0	1	1	43
22.5	X	X	1	0	1	1	0	0	44
23.0	X	X	1	0	1	1	0	1	45
23.5	X	X	1	0	1	1	1	0	46
24.0	X	X	1	0	1	1	1	1	47
24.5	X	X	1	1	0	0	0	0	48
25.0	X	X	1	1	0	0	0	1	49
25.5	X	X	1	1	0	0	1	0	50
26.0	X	X	1	1	0	0	1	1	51
26.5	X	X	1	1	0	1	0	0	52
27.0	X	X	1	1	0	1	0	1	53
27.5	X	X	1	1	0	1	1	0	54
28.0	X	X	1	1	0	1	1	1	55
28.5	X	X	1	1	1	0	0	0	56
29.0	X	X	1	1	1	0	0	1	57
29.5	X	X	1	1	1	0	1	0	58
30.0	X	X	1	1	1	0	1	1	59
30.5	X	X	1	1	1	1	0	0	60
31.0	X	X	1	1	1	1	0	1	61
31.5	X	X	1	1	1	1	1	0	62
32.0	X	X	1	1	1	1	1	1	63

4. X = not used, 1 = logic high, 0 = logic low

I²C Interface

The LED driver is interfaced through a 2-wire serial I²C-bus in order to control the state and the current in each of the six LED channels. The SDA and SCL lines comply with the I²C electrical specification and should be terminated with pull-up resistors. When the bus is not used, both lines are high. The device supports the maximum bus speed of 400 kbit/s. The serial bit sequence is shown below

for read and write operations into the registers. Read and write instructions are initiated by the master controller/CPU and acknowledged by the slave LED driver. The I²C address of the driver is internally fixed to the binary value 1100110. The protocol requires that the start bit and the device address are both repeated. For further details on the I²C protocol, please refer to the I²C-Bus Specification, document number 9398 393 40011, from Philips Semiconductors.

- Read operation:

S	Slave address	W	A	Register address	A	S	Slave address	R	A	Data	A*	P
---	---------------	---	---	------------------	---	---	---------------	---	---	------	----	---

- Write operation:

S	Slave address	W	A	Register address	A	Data	A	P
---	---------------	---	---	------------------	---	------	---	---

S: Start condition
 R, W: Read bit (1), Write bit (0)
 A: Acknowledge sent by the slave LED driver (SDA high)
 A*: Not Acknowledge sent by the master microcontroller (SDA low)
 P: Stop condition
 Slave address: Device address 7 bits (MSB first, slave address is 1100110).
 Register address: Device register address 8 bits
 Data: Data to read or write 8 bits

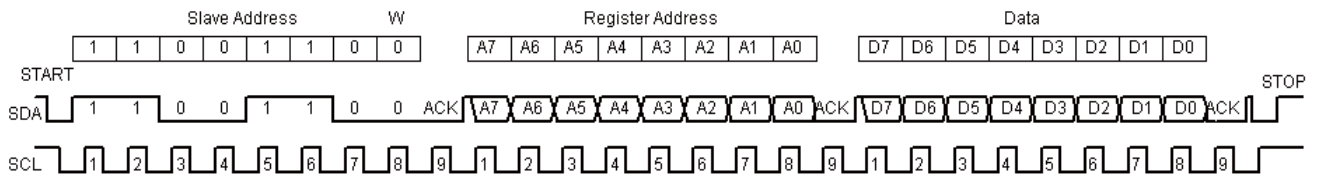

Figure 26. Write Instruction Sequence

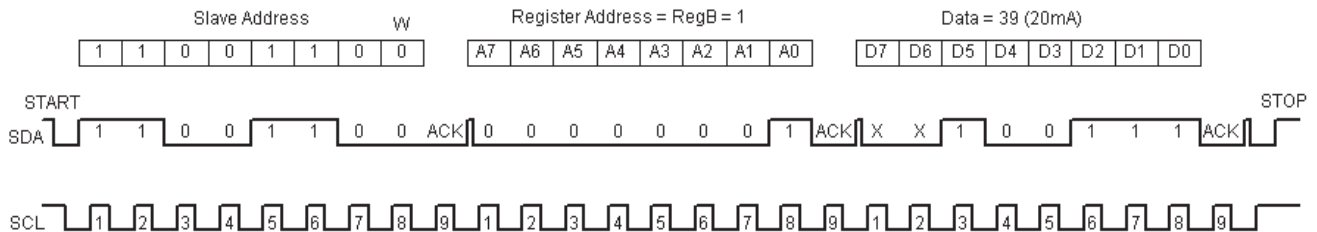

Figure 27. Write Instruction Example Setting 20 mA Current in LEDB1 and LEDB2

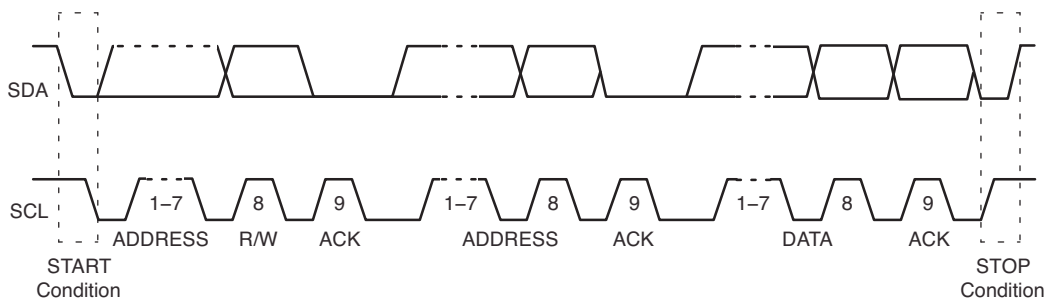

Figure 28. I²C Bus Protocol

W-5626

Typical Application

The W-5626 is ideal for driving RGB (red green blue) LEDs with common anode configuration. The individual LED currents associated with the red, green and blue LEDs are programmable independently through the I²C interface,

allowing to generate an accurate color mixing. Dimming while maintaining the same color can be done by reprogramming the RegEn register on and off with the appropriate duty cycle (PWM mode).

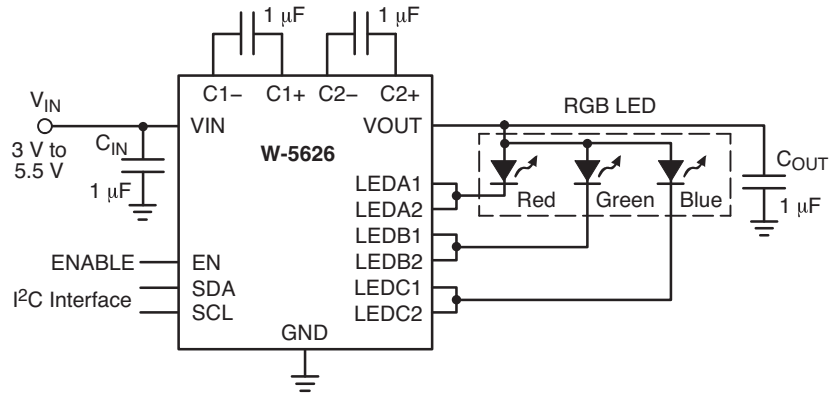
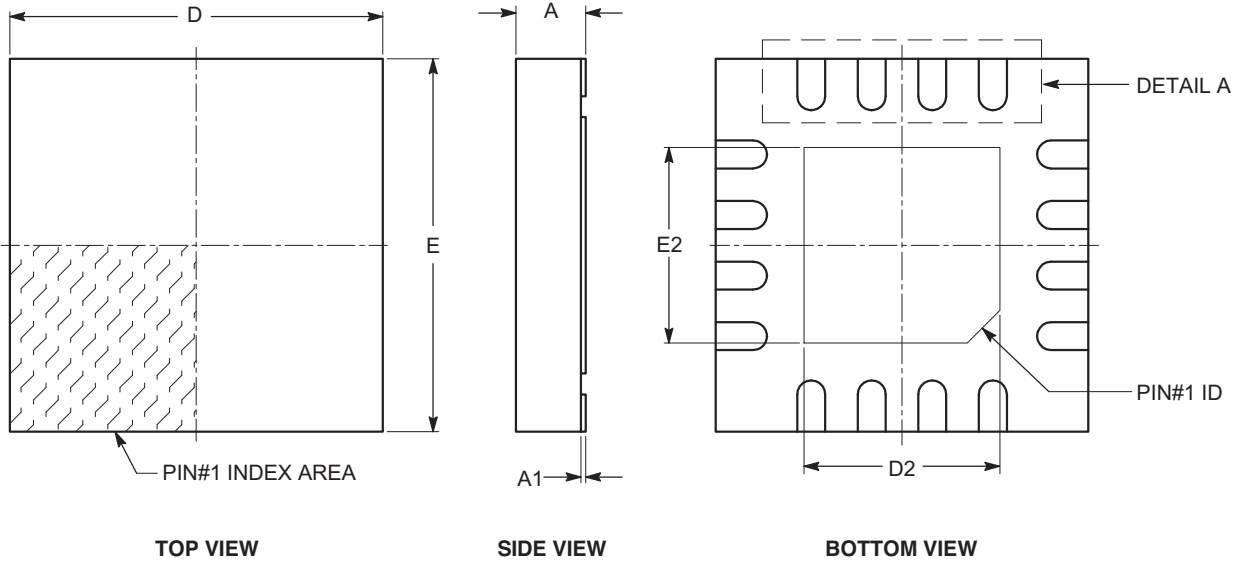

Figure 29. RGB LED

W-5626

PACKAGE DIMENSIONS

TQFN16, 4x4
CASE 510AE-01
ISSUE A



SYMBOL	MIN	NOM	MAX
A	0.70	0.75	0.80
A1	0.00	0.02	0.05
A3	0.20 REF		
b	0.25	0.30	0.35
D	3.90	4.00	4.10
D2	2.00	---	2.25
E	3.90	4.00	4.10
E2	2.00	---	2.25
e	0.65 BSC		
L	0.45	---	0.65

Notes:

- (1) All dimensions are in millimeters.
- (2) Complies with JEDEC MO-220.

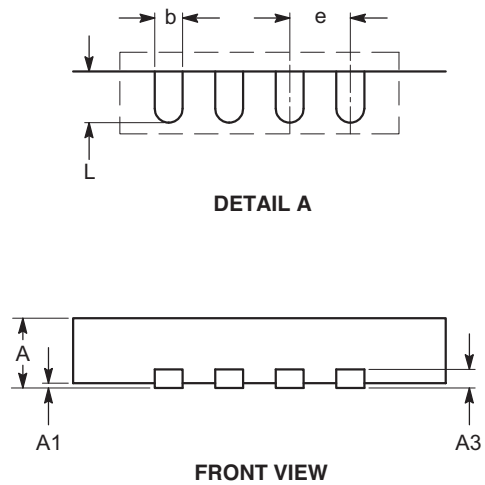

W-5626

Example of Ordering Information (Note 7)

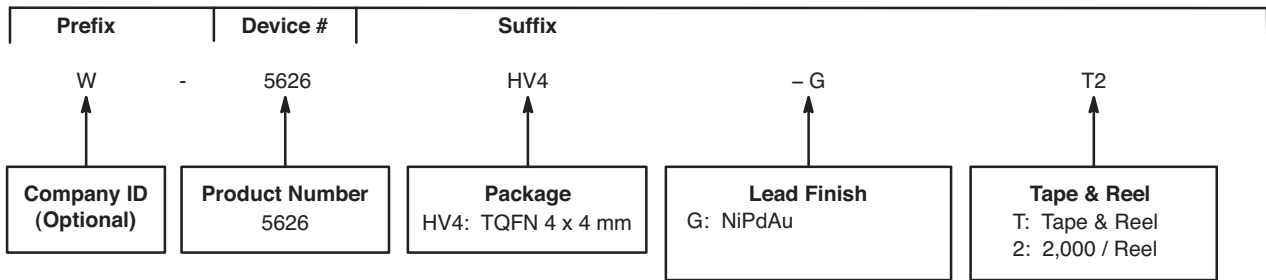

5. All packages are RoHS-compliant (Lead-free, Halogen-free).
6. The standard lead finish is NiPdAu.
7. The device used in the above example is a W-5626HV4-GT2 (TQFN, NiPdAu Plated Finish, Tape & Reel, 2,000/Reel).

I²C is a trademark of Philips Corporation. ON Semiconductor is licensed by Philips Corporation to carry the I²C Bus Protocol.

NIDEC COPAL reserves the right to make changes without further notice to any products herein.
NIDEC COPAL makes no warranty, representation or guarantee regarding the suitability of its products for any particular purpose, nor does NIDEC COPAL assume any liability arising out of the application or use of any product or circuit, and specifically disclaims any and all liability, including without limitation special, consequential or incidental damages. "Typical" parameters which may be provided in NIDEC COPAL data sheets and/or specifications can and do vary in different applications and actual performance may vary over time. All operating parameters, including "Typicals" must be validated for each customer application by customer's technical experts.
NIDEC COPAL does not convey any license under its patent rights nor the rights of others.
NIDEC COPAL products are not designed, intended, or authorized for use as components in systems intended for surgical implant into the body, or other applications intended to support or sustain life, or for any other application in which the failure of the NIDEC COPAL product could create a situation where personal injury or death may occur.
Should Buyer purchase or use NIDEC COPAL products for any such unintended or unauthorized application, Buyer shall indemnify and hold NIDEC COPAL and its officers, employees, subsidiaries, affiliates, and distributors harmless against all claims, costs, damages, and expenses, and reasonable attorney fees arising out of, directly or indirectly, any claim of personal injury or death associated with such unintended or unauthorized use, even if such claim alleges that NIDEC COPAL was negligent regarding the design or manufacture of the part.